



Makeshift Arsenal - Homemade explosives and Improvised weapons
version 1.2

The content of this file details extremely dangerous and illegal methods of making tried and true improvised explosives and weaponry. The explosives are far from safe, and by doing so your life is at risk. This file requires common sense to understand and if you are lacking in that department you should look elsewhere. You hold responsibility for your own actions and nothing you see on this sight should actually be done for your own sake.

The original location of this file has been deleted time and time again due to "unacceptable information" so i decided to use the format of an easy download that can be freely distributed throughout the world wide web, so feel free to take this file or parts of, and add it into your site as long as proper credit is given. - --Lowry

Use the FORUM to ask any questions, also please sign the GUESTBOOK.

GUESTBOOK - <http://pub1.bravenet.com/guestbook/show.php?usernum=13442260&cpv=1>

FORUM - www.surf.to/theforum

Index

key

* - methods original to this file that have been successfully completed and work well, although i seldom do something twice so care is needed, knowing that as far as i know it hasnt been tested under different situations by different people.

** - warning - taken from a source and not tested, although quite sure would work.

others are either general knowledge or are taken from a source that have been tested and found true, where possible i have included the original source where i first saw it under the heading but note that the methods for the particular product differ, as i only include the way its been successfully done by me, the original method may be better or worst but i dont know so ive only included what ive done so i know what im talking about.

1. EXPLOSIVES

- 1.1 - acetone peroxide
- 1.2 - expanding fishhook *
- 1.3 - HMTD
- 1.4 - hydrogen balloons *
- 1.5 - explosive putty *
- 1.6 - matchbox bomb
- 1.7 - bolt bomb
- 1.8 - blackpowder
- 1.9 - permanganate flash
- 1.10 - rifle primers *
- 1.11 - ammonium nitrate explosives
- 1.12 - smokeless powder

2. SMOKE BOMBS

- 2.1 - potassium permanganate + glycerine
- 2.2 - potassium nitrate + sugar

- 2.3 - ammonium nitrate + newspaper
- 2.4 - smokeless powder + PVC solvent *
- 2.5 - ping pong ball + Al foil
- 2.6 - chlorine granules + antifreeze

3. PRESSURE BOTTLE EXPLOSIONS

- 3.1 - dry ice **
- 3.2 - chlorine bomb **
- 3.3 - acid + metal **
- 3.4 - baking soda + vinegar **

4. ROCKETS

- 4.1 - shotshell rocket *
- 4.2 - estes skyrocket
- 4.3 - masking tape rocket *
- 4.4 - matchstick rocket

5. IMPROVISED WEAPONRY

- 5.1 - rocket launcher *
- 5.2 - matchbox claymore *
- 5.3 - semi-auto sluggun *
- 5.4 - R.C tank *
- 5.5 - spudgun
- 5.6 - rock-flinger *
- 5.7 - glove gun
- 5.8 - blow darts *
- 5.9 - shanghai
- 5.10 - sling shot

6. FUSE/WICK & IGNITION DEVICES

- 6.1 - salt petre fuse
- 6.2 - blackpowder fuse
- 6.3 - electric ignition
- 6.4 - party poppers
- 6.5 - insence sticks **
- 6.6 - bought fuse
- 6.7 - sparklers

7. INCENDIARYS

- 7.1 - napalm
- 7.2 - thermite
- 7.3 - shotshell tracer *
- 7.4 - chlorine firebomb
- 7.5 - petrol bomb **
- 7.6 - naphthalene

8. FUN THINGS TO MAKE AT SCHOOL

- 8.1 - blow darts
- 8.2 - spitball launcher / exploding pen *
- 8.3 - pen crossbow *

9. KILLING YOUR NEIGHBOURS CAT

- 9.1 - aspirin **
- 9.2 - snare

9.3 - mouse trap variations *

9.4 - explosive trap **

9.5 - steel traps

9.6 - cat products / taking the trophy *

10. EASY TRICKS AND TECHNIQUES

10.1 - things that explode in fires

10.2 - making a bang with a match head *

10.3 - sparkler in a bottle*

11. BEFORE, DURING & AFTER HOMEMADE EXPLOSION PICTURES

Includes -

ANNM

acetone peroxide

hmtd

ANFO

fuel + oxidizers

smokeless powder

1. EXPLOSIVES

1.1 - ACETONE PEROXIDE

(tricycloacetone peroxide)

(original source - "kitchen improvised blasting caps")

1. Go to the bank and take \$20 out

2. Head to the nearest chemist/pharmacy, go up to the counter and ask for 6% peroxide, the person will take you to where it is, buy as much as wanted - \$1.50 per 100ml. NOTE- all \$ are Australian.

3. next get back into your car and go to the hardware store (BBC, Mitre10 etc.), here you ask for acetone, they will get it for you - \$7.50 for 750ml.

Hydrochloric acid will also be here, you may get it here or go to another hardware store , just ask for hydrochloric acid - \$7 for 2.5 litres of 30% HCl.

4. You now have all the chemicals needed. How easy was that.

Below shows the necessary chemicals. Note the two bottles to the right and the layer of crystals on the bottom, this is 15hrs into the reaction.



5. Go home and find a large glass jar to mix the chemicals.

6. pour 200ml peroxide into glass, to this add 150ml of acetone than 50ml hydrochloric acid.

7. Stir these mixed chemicals for 2mins than put into the fridge, leave for a good 3 days.
 8. After 3 days all the crystals of A.P should have formed out of the mixture and formed a thick layer of white crystals in the bottom of the jar.
 9. Now is time to filter the crystals out of the solution, do this by folding a single piece of newspaper in the fashion shown than placing in the mouth of a large mouthed jar .
- diagram of filter method*

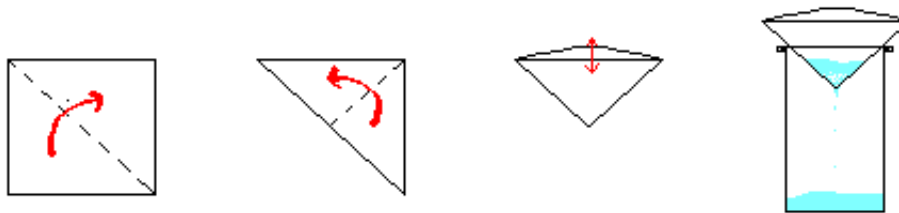

10. Once filtered you should have a substantial quantity of crystals in the bottom of the filte12. These dried crystals at this point are extremely dangerous, they are friction, heat and shock sensitive, you will now need to be careful to avoid any of these.

Characteristics

NOTE - The below information on acetone peroxide is not original to this file and was taken from a questionable source.

There are two forms of acetone peroxide: A dimer and a trimer. Both are high explosives and both are dangerous to handle. The trimer has about 80% the power of TNT.

A quantity the size of a pea in contact with a flame will burn instantaneously with a small 'pop' and producing a fireball. AP has been responsible for an alarming number of maiming due to it's friction sensitivity and high power. It is relatively benign when unconfined, but any sign of confinement will ensure that ignition will rapidly give rise to detonation.

Dimer Form (sulphuric acid method) :

Acetonediperoxide, Dimeric Acetone-peroxide, Acetonedimer Peroxide Cycloacetone Peroxide or Dicycloacetone Peroxide.

Trimer Form (hydrochloric acid method) :

Acetonetriperoxide, Trimeric Acetoneperoxide, Acetonetrimer Peroxide Cyclotriacetone Peroxide or Tricycloacetone Peroxide.

Formula : $C_6H_{12}O_4$

Brisance by sand test - 30.1 g sand crushed when 0.4 grams was initiated by 0.2 grams mercury fulminate (48 grams crushed by 0.4 grams TNT).

Impact sensitivity is 3" with 2kg weight (30" for TNT).

Volatility 66.4% lost at room temperature after 14 days - complete volatilisation in 3 hours at 75 degrees C.

Both forms are heat, impact and friction sensitive.

For the trimeric form,

Brissance - Phillips - 0.4 g initiated with 0.2 g Mercury fulminate crushed 34.1 g (48.0 g - TNT).

Volatility - complete loss after 40 days at 50 degrees C.

Detonation velocity 5290 m/sec in 6.3mm diameter column - density 1.2, 3065 m/sec in 15mm dia column - density 0.68.

Friction sensitivity - extreme.

Impact sensitivity - 4" with 500 gram weight.

Initiation capability - 0.05 grams compressed at 250kg/cm² initiated PETN.

Minimum charge to initiate TNT at density of 1.35 was 0.16 grams.

Power, a 10 gram sample gave 250 cc expansion in Trauzl Test (285 cc for TNT).

1.2 - EXPANDING FISH HOOK

A sure way to make your next fishing trip more exciting is to make some exploding fishhooks. It i also quite simple if you have the materials.

NEEDED - large cartridge case, primary explosive, party popper, epoxy, silicone sealer, hook, line & sinker.

STEPS -

1. Knock the primer out of the case.
2. Take explosive out of party popper and thread the string through the flashhole.
3. Tie hook to string and seal indent where primer was.

- The case is now filled with explosive (peroxides work well, gunpowder is not enough).
- A sinker with line attached is pushed into the neck of the case and neck is filled with epoxy.

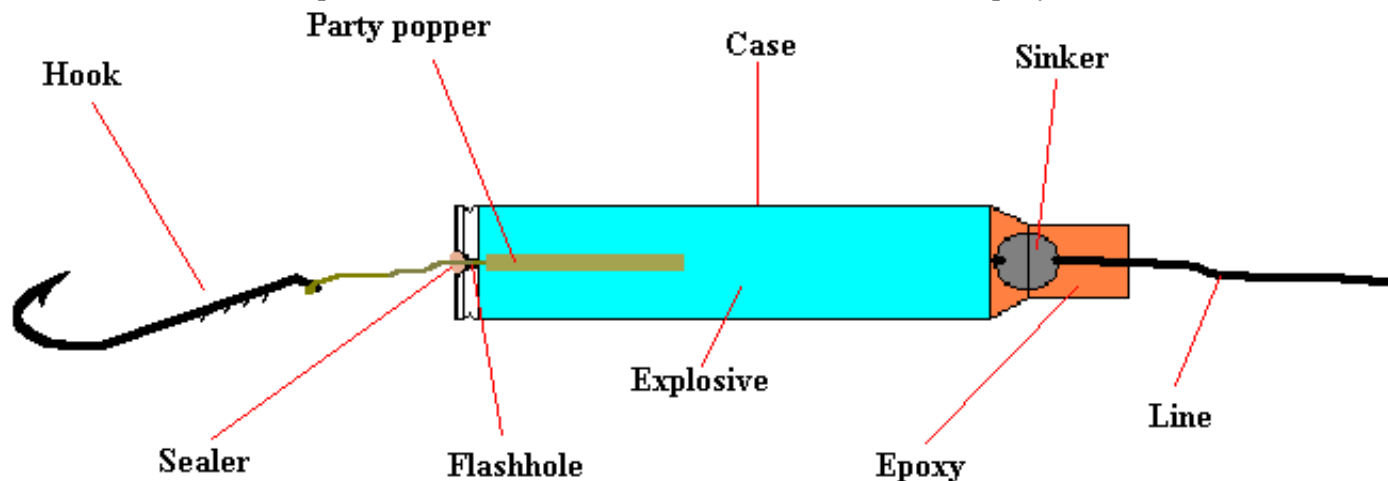

Now that its made the rest is simple. Tie it to the end of your line, bait up and cast in, now just wait for theTHUMP..... bubbles.....upside down fish.

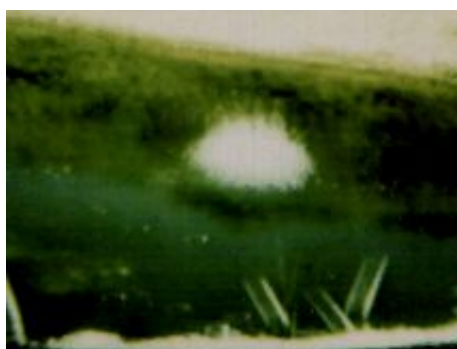

Above shows the fishhook detonating in about a metre of water, this shot is taken as the initial shockwave hits the surface, a couple seconds before the bubbles do.

1.3 - HMTD

(hexamethylenetriperoxidediamine)

(original source - "kitchen improvised blasting caps")

This explosive is very similar to acetone peroxide, perhaps a little less sensitive, however is very sensitive to contaminants and must be thoughterly washed before being used. If the contaminants are left in the material even slight increases in heat will be ample for detonation, this means even putting it out into the sun is dangerous. It is also harder to make than A.P and if the correct mixture of the 3 components are not added right no explosive will form, therefore i cannot guarantee the mixture below will work, trial and error will have to be used to obtain the optimal quantities of each chemical in the solution as i havnt been able to successfully replicate it every time.

The 3 chemicals needed are 6% Hydrogen peroxide, Hexamine and Hydrochloric acid. Peroxide is available at pharmacies (\$1.50 per 100ml), Hexamine at camping stores (\$3 for 8 tablets) and 30% HCl at hardware stores (\$7 for 2.5 litres). In a large glass jar add 100ml peroxide and 3 teaspoons of crushed hexamine, stir until disolved and leave for 30min., now add 30ml of HCl stir and sit in fridge overnight.

A considerable amount of fine white crystals should form out which are filtered, washed and dried in the same fashion as acetone peroxide.

DETONATION VELOCITY = 4511 m/sec @ 0.88 g/cc , 5100 m/sec @ 1.1g/c

Below shows what a 2.5 gram charge of HMTD did to a birdfeeder.



1.4 - HYDROGEN BALLOONS

Hydrogen is a very easily made, explosive gas. It also happens to be the lightest element, therefore by using the method below it is possible to fill a balloon with hydrogen which will float up into the air and explode when ignited.

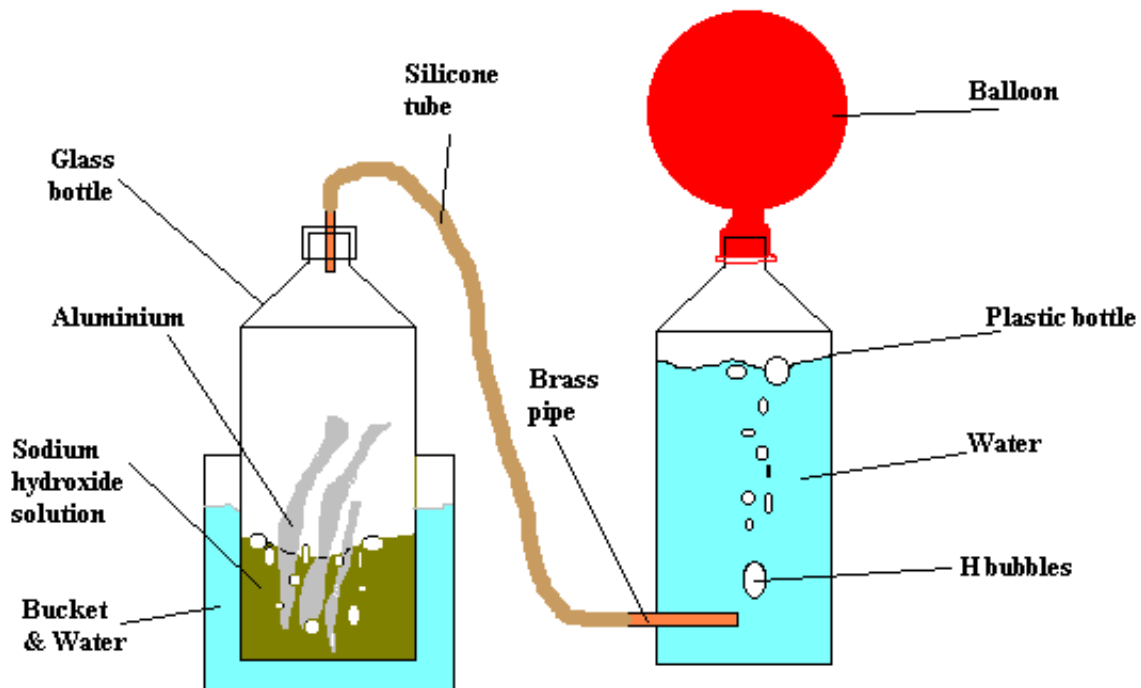

The bottle to the right contains the reaction between aluminium and sodium hydroxide (commonly sold as Caustic Soda in supermarkets \$3.50 for 500 grams), It is also possible to substitute sodium hydroxide for diluted hydrochloric acid. This reaction produces hydrogen, which runs through the tube, bubbles through the water and fills the balloon.

The second bottle full of water is used to condense any vapour that is with the hydrogen. It is possible to do without it however the vapour will condense in the balloon rendering it less boyant. By using the second bottle you also have the advantage of being able to keep adding aluminium without the balloon going down. Once balloon is full, remove and tie. The balloon must be reliably ignited or you will get a dud blast, ive found it best to run blackpowder up the sticky side of masking tape, stick to side of balloon than attach the fuse to the tape.

If youve done it all right these create a fireball, smoke cloud and a supriseingly loud, deep BOOM high up in the air.

1.5 - AP PUTTY

This explosive putty is made by the combination of two other explosives, those being acetone peroxide and double base smokeless powder.

First the smokless powder is turned into a paste by combining 2 parts powder to 3 parts acetone in a sealed glass jar, this is left for 3 days, you should now be left with a black paste with a viscosity slightly thicker than honey.

Pour the required amount of A.P into a bowl than slowly add the paste until the mixture has a mouldable density than remove. This is the explosive and to use just mould into a shape or around whatever, insert fuse and let dry (acetone will readily evaporate). when it is rock hard simply light fuse and run.

Below is the putty moulded in a matchbox, and the damage it did to a large milo tin.



The conversion to the putty explosive is my favorite, due to being very simple to purchase and make, able to be detonated via a simple fuse, no shrapnel and very powerful. When you see what damage this can cause and realise that it is solely from fast moving gas, you can see how effective this is.

I cant be sure how the addition of the smokeless powder to the acetone peroxide contributes to the explosion however it seems to raise the power. This may be from several reasons. It raises the density of the explosive resulting in more explosive per given volume. It increases the volume of gas produced for as the smokeless powder burns it too generates large volumes of gas. And also what i have been using is "double base" powder which is common for shotgun and pistol loads, this powder is a mix of nitrocellulose and nitroglycerine, There is divided opinion between if double base powders are able to be detonated as a high explosive however this may be another reason for the high power of this putty explosive.

1.6 - MATCHBOX BOMB

(source - "general knowledge")

Simply made by cutting the striker off the matchbox and laying over the matchheads like this.



It is slipped back into its cover and heavily bound with masking tape. it will explode when hit sharply on either end or chucked fast against a solid object.

1.7 - BOLT BOMB

(source - general knowledge)

By compressing powdered matchheads between two bolts in a nut, a basic impact ignited explosive is made.

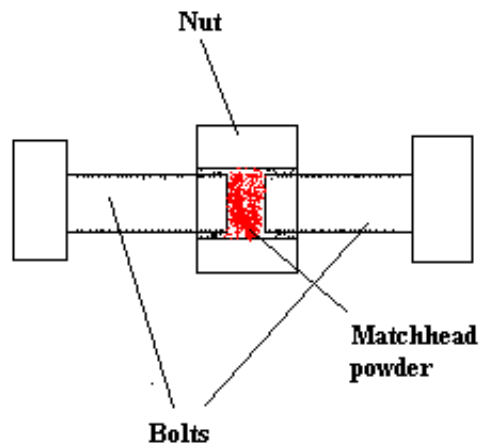

By throwing against a hard surface the matchheads will ignite blasting off one of the bolts.

1.8 - BLACKPOWDER

(original source - rec.pyrotechnics)

Blackpowder is probably the most common explosive to make at home, however making good blackpowder is hard and takes a lot of work.

The 3 components of blackpowder are Potassium nitrate (most pharmacies will order this - \$15 for 500gm or as a fertilizer coded 13-0-38 - \$25 for 25 kilo), Sulfur (pharmacy, or cheaper at a garden shop) and charcoal (burn something, preferably a soft wood). NOTE - all \$ are Australian

These are powdered to as fine a consistency as possible and intimately mixed in this ratio - 15:2:3. To achieve a reasonably fast burn rate there is the CIA method.

The CIA method takes advantage of potassium nitrate's ability to easily dissolve in water and its ability to then again recrystallize around the charcoal, forming a somewhat intimate mixture. The CIA method is also known as the precipitation method.

To make BP with the CIA method you will need to place your black powder into a saucepan then add a sufficient amount of water to make it into a sludgy mess. Place the saucepan on a hotplate and turn the heat onto low. Slowly bring it to a boil, then turn off the heat. Don't leave it there to boil away as the KNO_3 actually evaporates, leaving you with a batch of black powder that won't burn.

Put the mess into a saucepan containing some chilled alcohol. Why do we do this?

Well...as everyone who knows the properties of metals will tell you, heating a metal up (in this case potassium), then as quickly as possible cooling it down (this is called quenching), makes the metal form tiny crystals, and tiny is what we want. Once it has cooled down put your BP onto a piece of newspaper a few layers thick.

Smear it out so you can get it as thin as possible on the paper. Once you are happy that it is nice and thin (preferably around a 1cm or less) put a piece of newspaper on top, so it has paper on both sides, then place it on a piece of wood. Make sure the wood is hard as a soft piece of wood will tend to flex and not create as much pressure.

Next, put a piece of wood on the other side and clamp both together as hard as possible. Leave this sit in a nice sunny spot for a week.

When you go to collect it, it should be nice and hard. Break this up into small pieces, it should be still damp and when its like this i push it trough a mesh the size of a window sreen.This gives the powder sharp edges making it burn faster.The black powder made from this method is quite limited.

It is usually limited to making blackmatch, priming, and other things that don't require a fast burn rate.

1.9 - PERMANGANATE FLASH

(original source - "terrorist handbook")

The components needed for this explosive are Potassium permanganate (pharmacy \$3.50 for 50grams), Aluminium powder (Al foil in a coffee grinder), and Sulphur (pharmacy, garden shop).

These are ground as fine as possible, seperately, as this mix is very friction sensitive, and combined in this ratio - 3:2:1. The resulting powder will readily ignite via a fuse and emit a blinding white flash, the finer the aluminium the faster the composition will be.



1.10 - RIFLE PRIMERS

The explosive used in rifle primers (most commonly - lead styphnate) detonates violently with no confinement. The lead styphnate is also combined with various oxidisers & fuels to hotten and lengthen the flame. Watch for very old primers as they may contain potassium chlorate based mixtures.

Primers are available at all gun shops and are used to reload cartridges. Also available are percussion caps for use on muzzel loading weapons, these are larger than rifle primers and contain no anvil, these were most commonly loaded with mercury fulminate.

Lead styphnate (a mustard coloured powder) can be extracted from primers by soaking the primers in acetone, this dissolves the glue. Than pick the anvil out with a pin and srcape the wet explosive out and leave to dry. Shotgun primers are completely different and are completely enclosed except for an inbuilt flashhole thats sealed with a waxy substance, i cannot see a safe way of extracting the explosive from shotgun primers.

Small rifle primers also make excellent explosive ammunition for slug guns. The small primers are an exact fit for the .177cal bore and if shot against anything hard they will detonate loudly. Although i havnt tried small pistol primers out of a slug gun, they may be better than the rifle primers because of the thinner "cup" to increase sensitivity to the firing pin which may give detonation on softer targets.

These primers can also be added to small pipe bombs for added power. Just fill the pipe with primers, than add powder into all the gaps. Pipe bombs made this way are considerably more powerful and blast out a lot of shrapnel from the used primer cup and anvils.

LEAD STYPHNATE - Det velocity = 5200 m/sec.

MERCURY FULMINATE - Det velocity = 5400 m/sec.

Below is the explosive extracted from 20 primers, ignited unconfined.



1.11 - AMMONIUM NITRATE EXPLOSIVES

Ammonium nitrate is a common chemical that can be used to form very easily made and powerful high and low explosives. Ammonium nitrate can be accessed at farm supply stores and bulk fertilizer dealers, a pure AN fertilizer is available in Australia under the name of "Nitram" and it is also sold at farm supply in the blasting grade called "nitropril". Only use pure AN for all explosives.

AN as an explosive component has one major drawback, it is very hygroscopic, meaning that it will attract and absorb moisture from the air desensitising or destroying the explosive. This of course is overcome by containing the AN and finished explosive in an airtight container.

Ammonpulver

(original source - "cartridges of the world" book)

Ammonpulver is a German name given to a low explosive fuel oxidiser mix containing solely ammonium nitrate and charcoal, this composition contains an enourmous amount of energy for a simple physical mix with power close to that of double base powder containing a considerable amount of nitroglycerine.

However even though it contains the energy, its burn rate is slow and therefore is not suitable for bursting explosives.

Possible uses for this explosive are big bore gun propellant and rocket fuel. It has advantages over blackpowder in this role because of the increased energy, flashless and emits only a small amount of blueish smoke.

To make this composition -

finely powder ammonium nitrate and willow charcoal to as finer consistancy as possible (finer the faster and more efficient) and

mix to a ratio of 8 parts AN to 2 parts charcoal.

Once thoroughly mixed add methylated spirits until it clings together like thick mud.

strain this paste between two flat surfaces and leave to dry.. If your in the colder wetter months of the year dont bother as it will never dry.

Once hard break it up into small granules and its ready to use.

ANFO

(original source - TAFE blasting course)

ANFO is the most commonly used commercial and agricultural explosive as it is cheap and does a good job, this is the explosive farmers use to blow stumps out of the ground and mines also use it on mass. ANFO is the perfect earth mover with great heaving power brought about by a lot of effective energy and relatively low detonation velocity.

ANFO (ammonium nitrate fuel oil) can be manufactured by mixing 17 parts prilled AN with 1 part diesel and left one hour to let it soak in, it is then ready to use.

ANFO reaches its maximum effective energy at approx. 5.5% diesel remainder prilled AN.

It is sensitive to detonation from 2% to 12% at which point the prills are saturated and will not hold anymore oil.

The Det velocity is dependant on the density of the loading and the confinement of the charge but typically detonates within the range of 3000 to 4500 m/sec. The denser and more confined the higher the DV, it will have a density of approx. 0.8g/cc in the prilled form.

Properly mixed anfo will detonate to 50 grams of high explosive.

ANNM

(original source - kitchen improvised fertilizer explosives)

ANNM (ammonium nitrate nitromethane) is a very powerful and sensitive binary explosive that holds more power and is more brisant than any commonly available commercial explosive (with the exception of PETN in detonators and det. cord).

To make ANNM 1 part pure nitromethane is added to 5 parts powdered AN and left 1 hr to soak in, in sealed container.

This explosive is very sensitive and ive never failed to detonate it using either of the peroxide explosives, to guarantee initiation a matchbox full of the explosive putty should be used however you could probably get by with half this amount.

ANNM plastique

(original source - kitchen improvised plastic explosives)

This is a very useful explosive containing the same qualities as strait ANNM but in a plastic mouldable form.

To make first add 1 part smokeless powder to 2 parts nitromethane in a sealed glass container, the nitromethane being a powerful solvent will break down the nitrocellulose and you will be left with a black sticky substance that will act like jelly.

Now finely powder AN and add 1 part of this "jelly" to 3 parts AN and knead together with gloved hands (I got some terrific headaches after playing with this stuff, not sure what was the cause of it however what i used was double based powder in which case the nitroglycerine may have seperated and was absorbed into my skin so BEWARE)..

Below shows the finished plastic explosive and suitable detonators, the smaller detonator is acetone peroxide pressed into a .22 Khornet case with the larger more reliable one being a matchbox of the AP putty, both are fused with proper explosive safety fuse



1.12 - SMOKELESS POWDER

Smokeless powder is a nitrocellulose based propellant that is now the universal propellant used in most modern cartridges (you know, the things guns run on, "bullets" you may say).

It is possible to make nitrocellulose, however it involves the mixing of sulphuric acid, nitric acid and cotton, ive never done it so im not going to attempt to explain it to you. However its not that hard to obtain, you can buy it by the kilogram at gun shops for the purpose of reloading ammunition or simply empty a few cartridges, this assumes you know someone with a firearms licence or have one yourself, as gunpowder is not sold to just anyone.

There's an enormous amount of types and brands of smokeless powder all with different burn characteristics, one thing they do have in common is that the burn rate increases with confinement, that means if you light a pile up out in the open it will burn slowly with a large orange flame but confined its burn rate increases considerably.

SP comes in two common forms, that is single base which contain straight nitrocellulose and other various nonenergetic additives, the other, double base which contains nitrocellulose colloided with varying amounts of nitroglycerine. These two types can then be divided up into grain types which are commonly flake, disc, tubular and ball, flake will commonly be the fastest and is primarily used in shotshells and other compressed powder rounds.

Examples of single base propellant are - win 760, AR2213, IMR 4198

Examples of double base propellant are - Hercules bullseye (fastest SP with highest NG content available), green-dot, red-dot and win 500HS.

One very interesting characteristic of double based powders is their ability to detonate as a high explosive. That means, if excited by a detonator the powder will dramatically increase. (look at "before,during & after pictures" for the test i conducted to come to this conclusion).

2. SMOKE BOMBS

It is very simple to make effective homemade smokebombs. All the methods below produce thick clouds of smoke with little to no flame.

2.1 - POTASSIUM PERMANGANATE + GLYCERINE

(original source - "curiosity show")

Mix a 1:2 ratio of potassium permanganate and glycerine in a matchbox, shut the box and shake. The delay will depend on the temperature of the day and grain size of the P.P crystals, the hotter the day and smaller the crystals the shorter the delay. after the delay the box will fizz and emit a cloud of white smoke.

2.2 - POTASSIUM NITRATE + SUGAR

Mix equal parts potassium nitrate and sugar in a metal or glass bowl, this is then carefully melted over a hot plate. This molten mix is poured into the container (i've found toilet rolls are a good size) , a fuse is inserted and it is left to set. The toffee like mix that you now have is the smoke bomb, and is ready for ignition.

2.3 - AMMONIUM NITRATE + NEWSPAPER

Probably the easiest and most effective of the homemade bombs is this one. It's become my favourite. All that's needed to do is make a strong solution of water and ammonium nitrate, in this soak a newspaper, when saturated take out and hang in the sun to dry.

When dry roll up as tightly as possible and tie up with string. the bomb is completed.

just ignite the end of the roll of treated newspaper and it will fizz like a rocket and blast out thick clouds of white smoke.

The bomb below was made with only 2 sheets of newspaper



2.4 - SMOKELESS POWDER + PVC SOLVENT

In a bowl add some smokeless powder, to this powder add just enough PVC solvent/cement to bind the powder together, mould this mix into the shape desired and let dry.

This can't be ignited by bare flame or it will simply burst into the flame, what's needed is something red hot such as a match that has just been blown out or a red hot wire.

2.5 - PINGPONG BALL + ALUMINIUM FOIL

This is probably the easiest to make and quite effective, made by wrapping a pingpong ball with foil and heating over a flame.

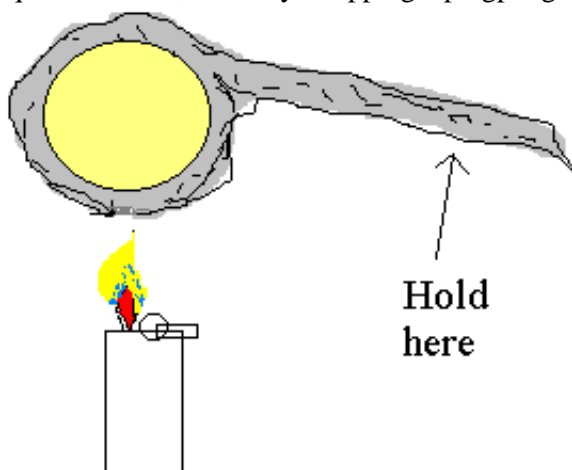

When it starts to fizz chuck away and either smoke will pour out of it or if your unlucky it will burst into flames.

2.6 - CHLORINE GRANULES + ANTIFREEZE

This is another very easily made one, by combining 2 parts pool chlorine with 3 parts antifreeze in an unsealed container a chemical reaction will take place in around 10 to 15 seconds and produce large volumes of toxic white smoke. The size of these bombs can be quite big because of the ease of acquiring the bulk materials.

3. PRESSURE BOTTLE EXPLOSIONS

The easiest explosive to make in the home would have to be a pressure bottle explosion, these bombs use the increase in pressure in a bottle brought about by a chemical reaction to burst the container creating a loud boom. Common sense plays a

large part in the construction of these devices as the delays before the explosion can be unreliable. Always test the reaction before attempting one of these if its too fast or too slow its too dangerous. Once one of these are set up dont go near the bloody thing until it has gone off and if it doesnt seem to be working youll have to shoot it or something, again USE COMMON SENCE. Shown here are the easiest of this form of bomb.

3.1 - DRY ICE + WATER

Simply put, a plastic bottle is 1/5 filled with dry ice (solid CO₂) water is added, than quickly the cap is replaced on the bottle. The dry ice will melt releasing carbon dioxide which will pressurise the bottle until it bursts. The delay depends greatly upon the size of the chunks of ice and the temp. of the water, the smaller the parts of ice and hotter the water the faster the reaction and shorter the delay.

3.2 - CHLORINE BOMB

The popular chlorine bomb uses the reaction between pool chlorine granules (65% calsium hypochlorite) and one of various other reactive chemicals, these can be - antifreeze/glycerine (lot of smoke), brake fluid (flame), hexamine/sulphur (long delay), thats all ive tried but im sure theres a lot more. To use, a bottle is filled 1/6 way with chlorine than the other chemical is added, cap replaced than get away from it.

3.3 - ACID + METAL

This uses the reaction between an acid and a reactive metal. The easiest would have to be hydrochloric acid and aluminium. The acid may have to be diluted with water if the reaction is too quick. The bottle is 1/6th filled with acid than the required amount of aluminium is added, cap srewced on and run. The reaction produces hydrogen which fills and bursts the bottle (for a use of this explosive gas see hydrogen balloons.

3.4 - BAKING SODA + VINEGAR

The reaction between baking soda and vinegar is far too fast to be used in the same fashion as the other methods on this page. This device must be set up and knocked over when it is intended to go off, you decide how this is done.

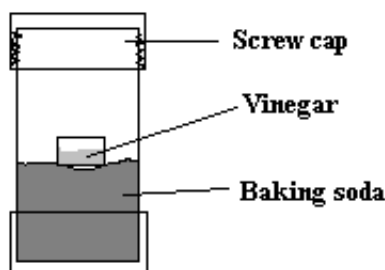

4. ROCKETS

4.1 - SHOTSHELL ROCKET

If the you have access to the components this is quite an easy rocket to make in the home.

The casing is made from a deprimed shotshell case, preferably of the "high brass" type. The propellant is simply a mix of 1 part blackpowder to 4 parts smokeless powder, these powders are finely powdered than dampened with acetone. the rubbery mass is than pressed into a shotshell wad (easily bought for reloading purposes) and left in the sun to dry.

When dry you will have a solid block of powerful propellant that provides more thrust and power than any commercial blackpowder based rocket.

Next take a spent shotshell and knock the primer out. The hole left will act as a nozel for the rocket. Epoxy is than smeared onto the side of the wad, the wad full of propellant is can now be pushed down backwards into the shell, epoxy is than added to the top of the wad and tissue is rammed into the remainder of the shell and sealed shut with masking tape.

A 40-50cm piece of cane is taped to the side of the shell, the nozel is filled with blackpowder to ignite the propellant and a fuse is taped to the powder, and the rocket is complete.

To use - the cane is pushed loosly into the ground and fuse is ignited.. The rocket is remarkably fast and reaches a great altitude, most of the time you wont be able to keep your eye on it.

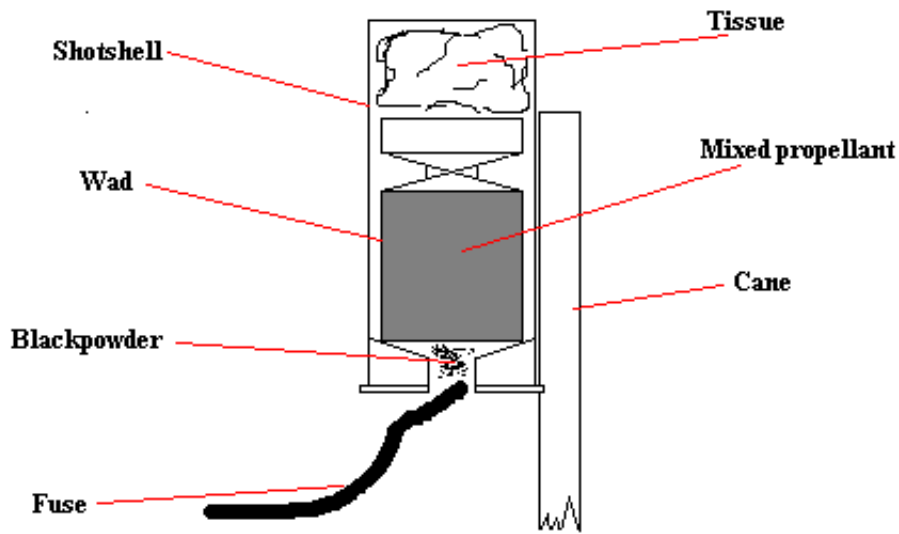

4.2 - ESTES SKYROCKET

Estes rocket engines can be bought at most hobby shops, although expensive (\$5+ per shot) they can be used to make an impressive skyrocket. This rocket takes advantage of the ejection charge in the engine, this charge detonates at the maximum altitude of the rocket and ignites the main charge of blackpowder and stars. These stars are most easily made from smokeless powder and blackpowder binded with acetone. Pure nitrocellulose stars can be used to give soft orange fireballs however they have a habit of being blown out, by adding a bit of powdered blackpowder the stars will be a more intense white colour with a lot less chance of going out.

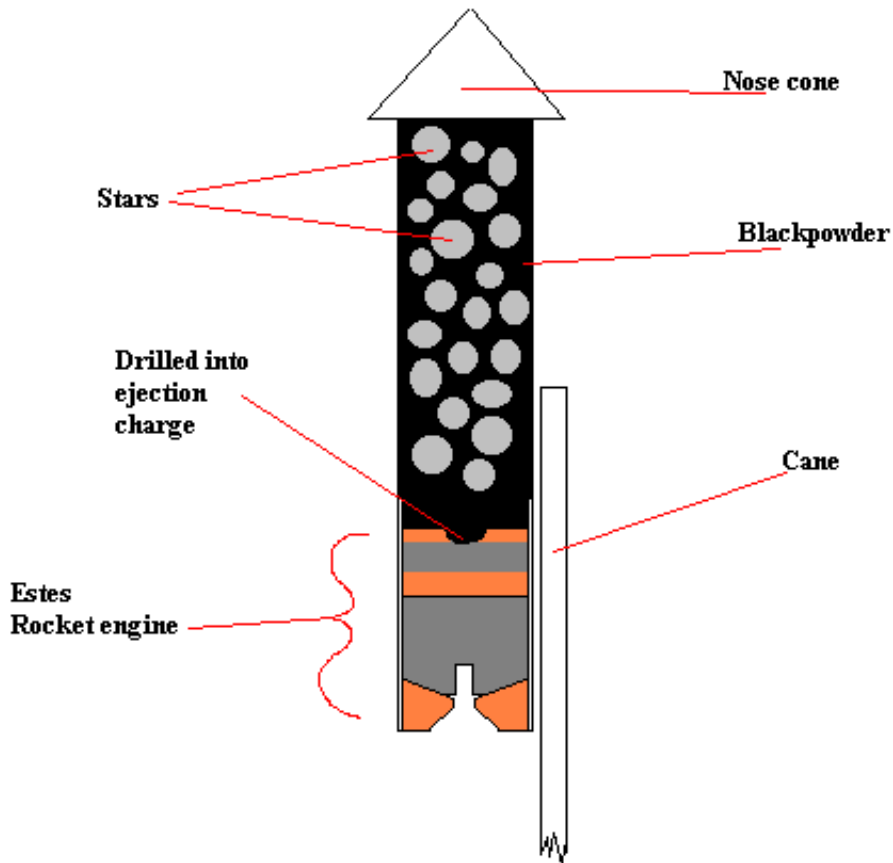

4.3 - MASKING TAPE ROCKET

On some inch wide masking tape run a line of a fast smokeless powder straight down the middle, than fold in half widthways and roll up into a straw shape. Now bind the length with 1-2 layers of masking tape making sure one end is sealed and the other open.

To stabilise this rocket a feather is taped to the open end.

Its easiest to launch this rocket out of a tube, simply place in a tube and hit the oped end with a lit match, these are good for about 50 metres at the best of times.

4.4 - MATCH ROCKET

For a dead easy little rocket to launch around these have to be the easiest. Just follow the diagram below making sure the matchstick to the left is a loose fit.

Stick the match on the left into the ground or other and heat the bulge where the matchhead is.

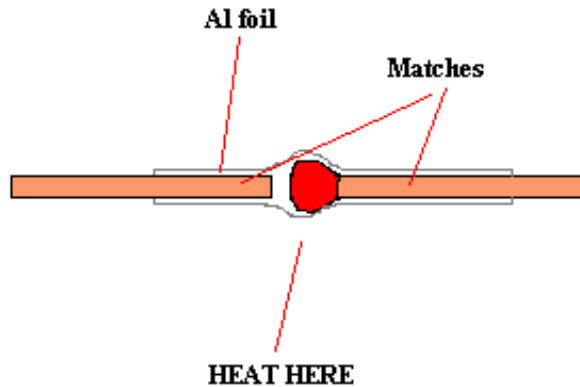

You'll get a fsssht and the match/foil will shoot a few metres.

5. IMPROVISED WEAPONRY

5.1 - ROCKET LAUNCHER

This weapon is possibly the most impressive and most dangerous to use on this page. Although basic in design it utilizes simply found materials to make a devastating weapon.

below is a photo of the finished rocket launcher



The launcher itself is simply an aluminium pipe, partially blocked at one end. A switch is built into the handle along with a 9 volt battery so that when the switch is pushed, the circuit is completed and the igniter ignites.

The blockage at the back end is vital, as the bought rocket engines are designed for vertical flight the initial thrust is not powerful enough to quickly gain the velocity needed for horizontal flight, and will simply plough into the ground after a few

metres. However with the back end partially blocked the gas from the rocket engine will pressurise the tube as the rocket is launched in the same fashion as a bullet fired from a rifle giving the rocket a far flatter trajectory.

diagram of rocket launcher

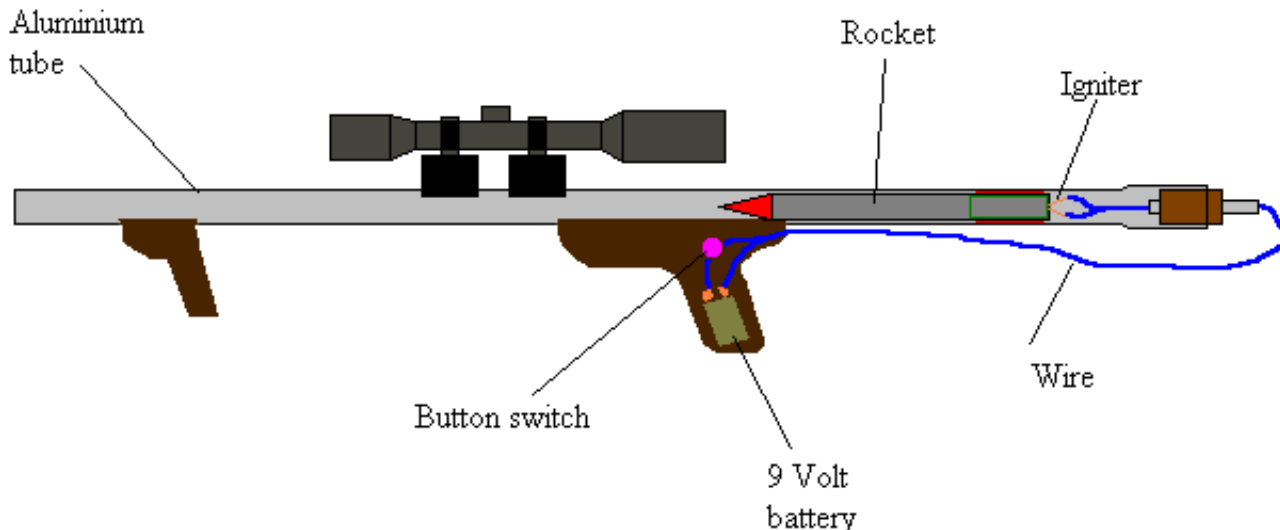

The rocket is powered by a bought estes D class engine, these can be found in most hobby shops however are rather expensive at around \$7-8 Australian per shot, trying to improvise a homemade rocket engine only increases the already high risk of an accident.

The rocket is detonated from the ejection charge in the rocket at a set distance, this is the safest and most reliable way.

The rockets body is made from thin aluminium tubing (again available at hobby shops), The rocket engines ejection charge is drilled into (clay on top of engine) until you hit the black stuff (blackpowder). The engine is than glued with araldite or equivalent into the Al pipe, the pipe is filled with the explosive charge eg. blackpowder and nose cone fitted.

To stabalize the rocket you can do two things that I know of , they are add fins or add spin to the rocket. The method below to some extent does both.

The fins are cut from a flexible plastic (I used the cover off a ring binder) and glued with a strong epoxy to the sides of the rocket. when the rocket is pushed into the launcher the fins are folded around the body of the rocket.

diagram of the rocket

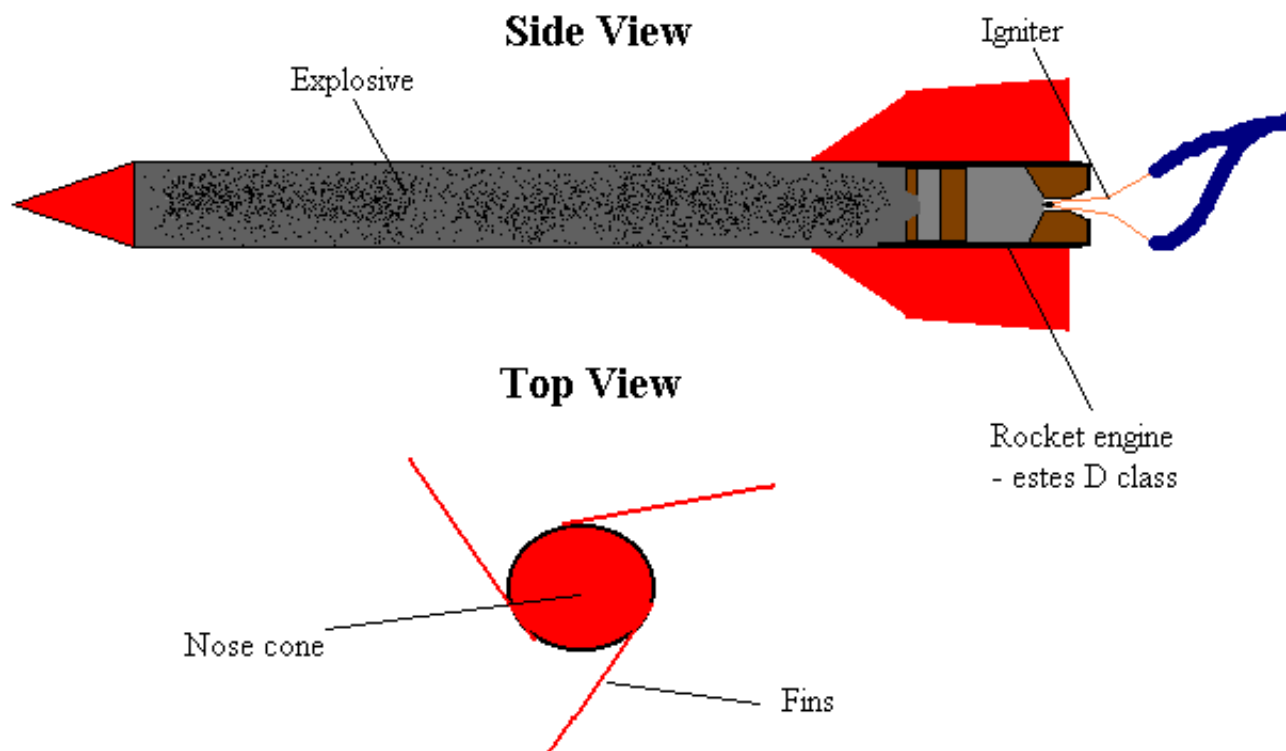

5.2 - MATCHBOX CLAYMORE

A miniature claymore mine ... or to be politically correct a miniature claymore command detonated anti personel fragmentation device due to mines now being banned, can be made around the basic explosive being the explosive putty for the method of making this explosive see the "explosives" page.

First the explosive putty is moulded in a matchbox so you left with a rock hard block of the explosive, another matchbox is filled with a mix of nitrocellulose paste (smokeless powder dissolved in acetone) and BB's (these can be bought at gun stores for use in BB guns, no licence is required) use just enough of this paste to bind the BB's together. If the not so politically correct tripwire version is wanted a small centrefire rifle case (no wider than a .222 Rem. case) with explosive out of party popper inserted through flashhole is pushed right throught the centre of the block of BB's so that the explosive will ignite when the string is pulled. If an electrically detonated device is wanted simply push a rocket igniter into the explosive putty as its drying. Once this mix is dried smear some nitrocellulose paste on the surface of one side of the block of explosive and stick the block of BB's to it. It can than be glued to a steel plate in the same fashion.

diagram

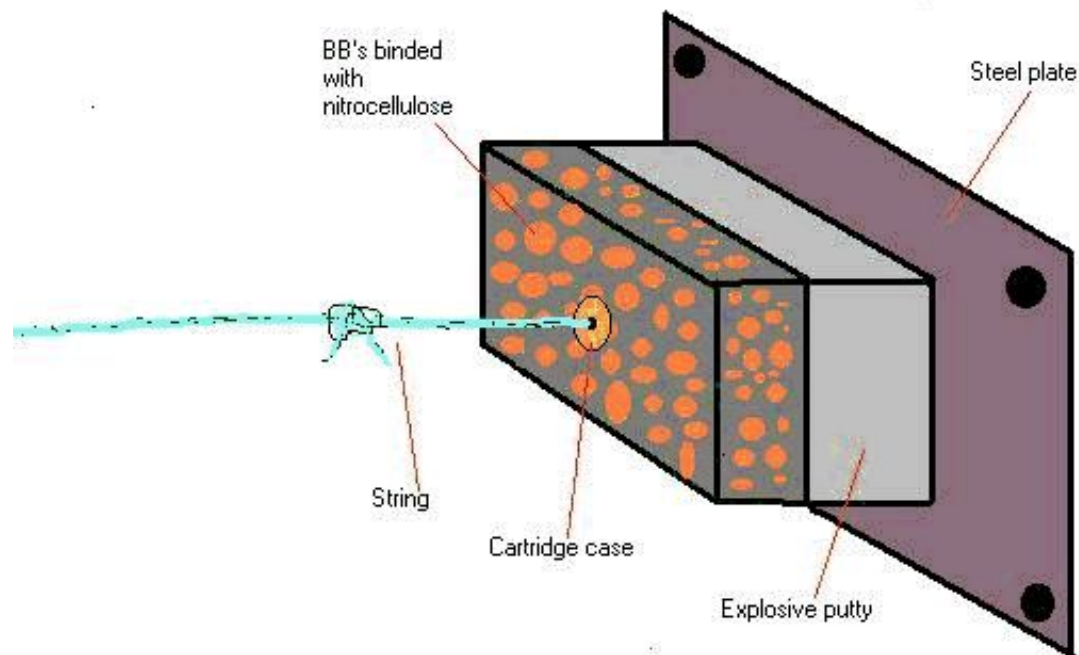

This device contains approx. 300 BB's in front of around 20 grams of explosive. As a matter of interest proper claymores contain 700 steel balls in front of 700 grams of C4.

Below is the finished claymore wired for electrical ignition, once detonated this mine chucked the steel girder over 10 metres and put a large dent in it and the BB's held a much tighter pattern than expected.



5.3 - SEMI-AUTO SLUGGUN

This weapon is more complicated than any other on this page and can be fiddly to get to work smoothly without jamming however if made correctly is an impressive addition to any homemade arsenal.



The idea is rather simple however rather hard to get to work. The gun is powered by an aerosole can that is fitted into a recession in the stock. There is an inner and an outer barrel in which the inner slides freely within the outer. I found these tubes at a hobby shop. the inner has to be a perfect fit for an air rifle slug and also inside the outer barrel.

As the picture below shows, as the trigger is pulled back the inner barrel also moves back sealing the hole in the inner barrel for the magazine against the top of the outer barrel. As the inner barrel moves back it also pushes down on the nozel of the aerosole can sending a jet of gas up the barrel shooting off the slug, the trigger is released, the barrel moves forward and another slug falls into the barrel and is ready for the next shot. A fully automatic version may be made possible by mounting the magazine back along the barrel so as the barrel slides back the hole opens in the magazine allowing slugs to freely flow into the path of the flowing gas. For this to work a stronger power source would be needed.

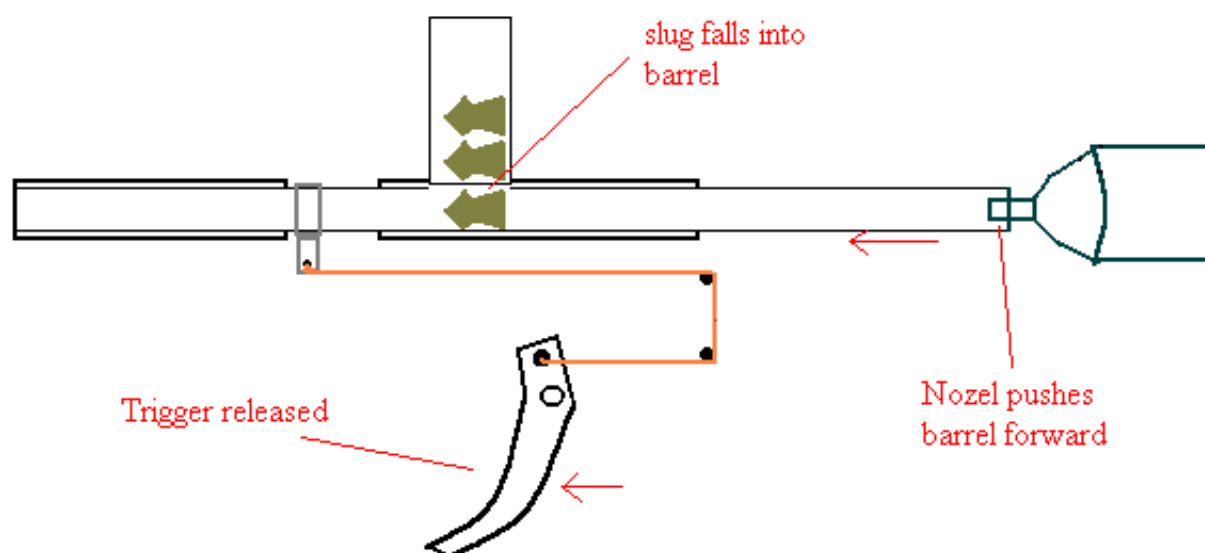

To avoid jamming pointed slugs should be used, another possibility that i hadnt thought of while constructing this weapon is the use of steel BB's , if these were used there would be no problem of jamming and it may be possible to hold the BB in the barrel by use of a magnet to stop it rolling out the end of the barrel.

5.4 - R.C TANK

This device is sure to scare the shit out of anyone it comes across. This weapon ulilizes common radio gear that can be bought at any hobby shop to make a radio controlled switch that when switched this completes the circuit from a battery to an electrical igniter, igniting the propellant in a shotshell firing the cannon.

photo

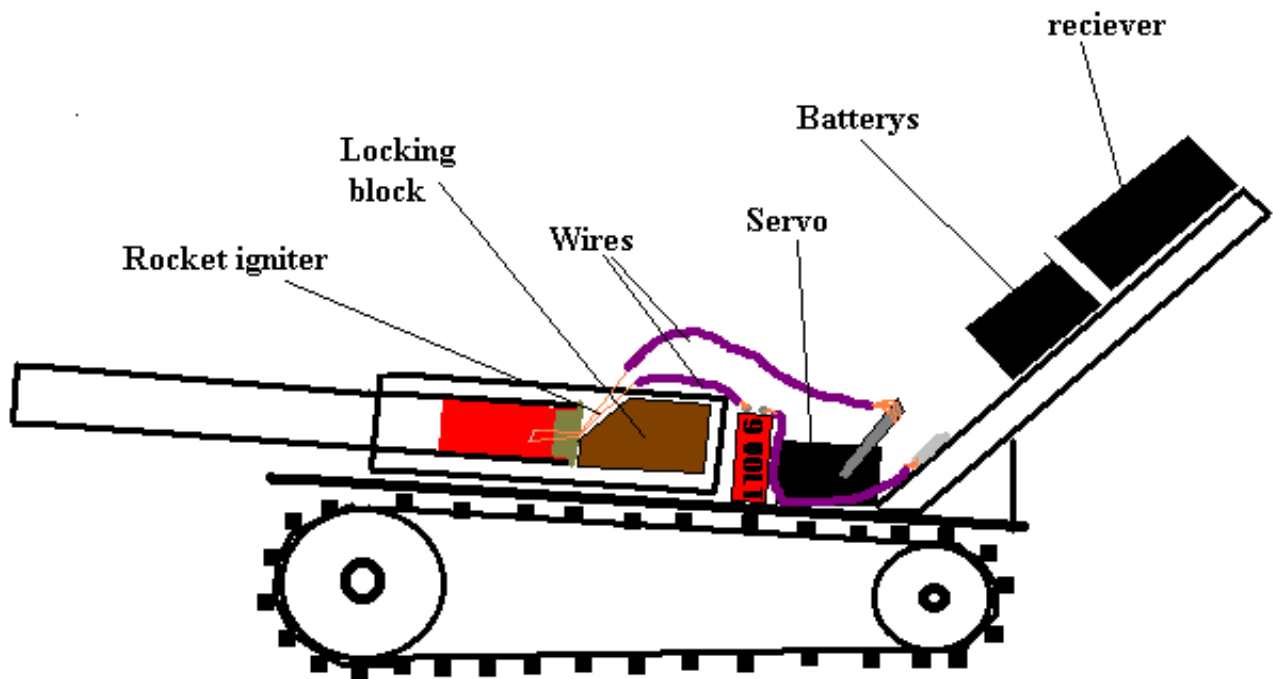

The one below is fitted with 12 ga, 20 ga and .177 cal barrels. The two shotshells are ignited electronically while the .177 cal is actually an air rifle slug loaded into a .22 rimfire case using the priming as a propellant, this is discharged by use of a hammer.



5.5 - SPUDGUN

The spudgun/orange gun is of the most basic of designs on this page, dont be fooled by all the fancy vent holes and crap you see on the one below as its all just for looks. Its constructed entirely of PVC pipe, be sure to get the thickest PVC available. The main parts of the spudgun are the Igniter, Combustion chamber and Barrel the propellant is any flammable gas eg. deodorant,

hairspray etc. Also avoid stuffing a hydrogen balloon into the chamber for a bit of added power as this is responsible for blowing my gun up.

photo of my spudgun



To fire this weapon -

1. precut potato with a section of tube the same size of barrel, the inner edge of both this cutter and barrel should be bevelled to allow easy cutting and insertion into barrel.
2. unscrew end cap.
3. ram cut potato down the barrel until it reaches within a couple inches of end of barrel.
4. spray desired amount of deodorant into chamber and quickly screw end cap back on.
5. the weapon is now ready to fire. If the igniter is pushed the gas in the chamber will ignite producing gaseous expansion highly pressurising the chamber firing off the now projectile.

The gun below was made with a 2" diam. barrel opening up to a 4" chamber than again into a 6" chamber, the igniter is a common refillable fire place igniter. These weapons are very effective and will chuck a heavy potato 200 metres, this is enough to knock a man clean off his feet.

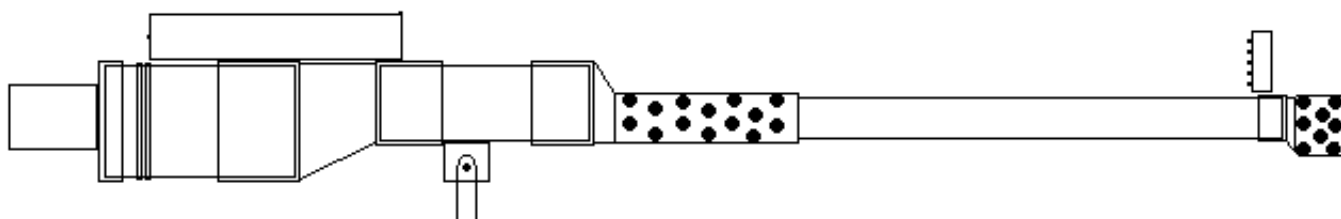

Making a sight for the gun proved more difficult, as it seemed nothing would work, i tried both a scope and conventional open sights but proved unreliable at best. What i settled on was a combination of both, it combines both the crosshairs of a scope and the sighting plain of open sights along with further horizontal crosshairs near the muzzle to choose the range. (no its not as complicated as it seems.. really)..

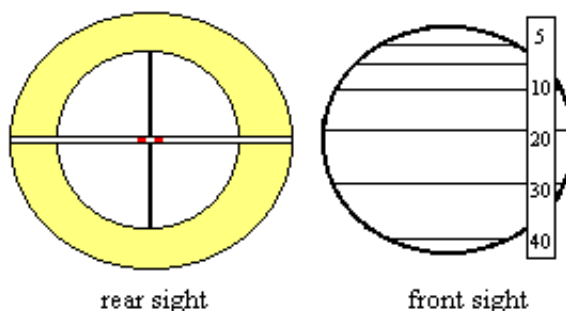

Getting a consistant velocity from the gun is the hard part, pre charged compressed air guns would have the edge over the combustion guns in this respect but a downside of decreased fire rate.

Pre charged guns are more reliable and safer as long as you work within the limits of the gun.

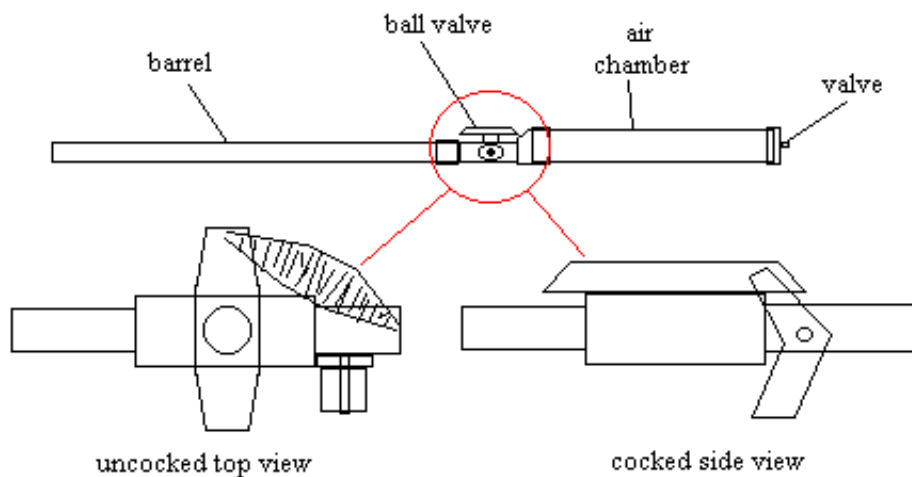

The above gun is charged from an air compressor through a tyre valve inserted in the end cap.

The ball valve has been fastened up by adding a trampoline spring and a trigger, as the faster you can open the valve the more power the gun will have.

To fire - cock and load the weapon, charge through valve to max pressure, pull trigger back.. adding lubricant to the valve and barrel will increase velocity.

5.6 - ROCK-FLINGER

A basic design that works on the same principle as a shanghai. this is capable of launching rocks around 150-180fps To make one what is needed is - square length of wood (1" x 1" x 4') garden stakes work well, thick rubber bands x2, thin rubber bands x2, clothes peg x2, tacks.

First tack the thick rubber band to the end of the pole, than tie the other thick band onto the band. Now araldite the peg to the other end, and break open another peg and remove the spring. With this spring open the wires coming out from it up, and thread the last rubber band through the gap.

Now stretch the rubber bands back open the peg and shut it onto the spring, reinforce the peg with a further couple of bands to keep the weapon set.

Load the weapon by sliding a rock etc. inbetween the rubber band where its attached to the spring. To fire simply push down on the peg.

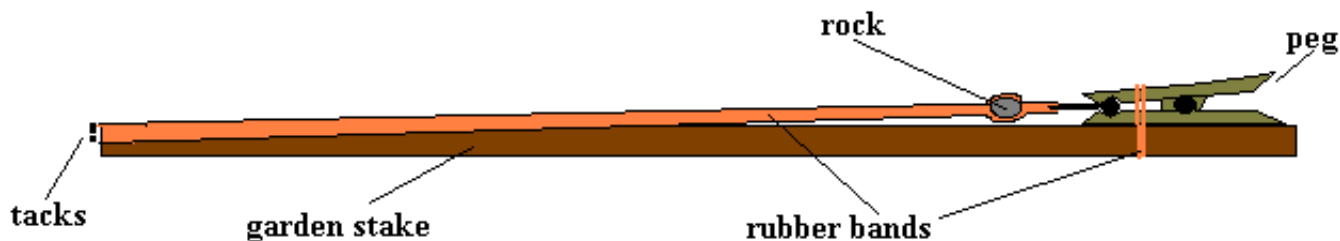

5.7 - GLOVE GUN

This is made by cutting the top half off a bottle, than a finger off a rubber glove is pushed onto the neck of the bottle and taped securely.

To fire, load it by dropping the wouldbe projectile down into the bottle and letting it fall into the end of the finger, grasp the projectile through the glove, pull back and let go.

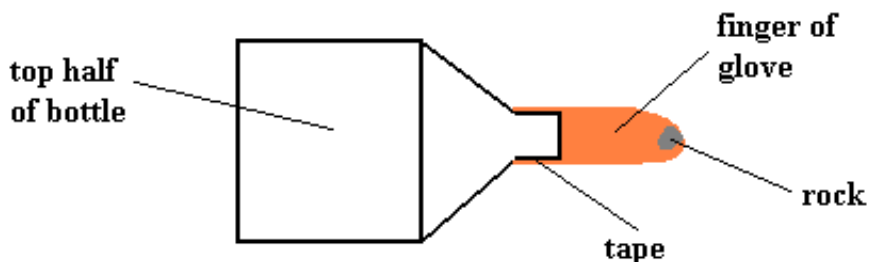

5.8 - BLOW DARTS

First find a wooden skewer, around 3mm thick, cut it off and trim it too about 15-20cm. Next split the end with a sharp knife, take a needle and dip the eye in epoxy than insert the needle into the split, now bind the needle in securely with cotton, once tight cover the cotton with a coat of glue To stabilise and make the dart have a nice fit in the tube, cut a cube of soft foam (like the stuff in mattresses) push a hole through the centre and slip onto the other end of the dart and tie it on with string, now trim the foam until it fits nicely into the tube The blow gun itself should be a rigid tube no less than 4 foot in length and around 1.5cm diam. Load the weapon by pushing the dart in needle first through the mouth piece until the foam is an inch inside the tube. now give a sharp blow through the mouthpiece.



5.9 - SHANGHAI

Everyone should know this one, easily made, accurate and effective best describes this weapon. A shanghai can be made with a variety of materials, a steel rod 5mm thick being ideal but if not available a strong forked branch preferably with a bit of spring can be used. The most important part however is the elastic material that is needed to provide the power. The proper bands every now and again show up in Australia and are ideal for a steel shanghai and costing around \$10, however if unavailable can be substituted for various materials. These can be thick elastic bands, strip of rubber from the inner tube from a car tire, strip cut from bladder inside football etc.

The last part needed is the pouch, needed is a strong piece of material ideally leather about 5cm x 10cm which has two vertical slits cut into it at the short ends. thread the rubber through the slits, double it over and tie it up with string. Do the same to attach it to the forked limb.

To use, hold a rock / BB / lead shot etc. in the pouch pull back, aim and let go. If the metal weapon was made its best to incorporate an arm support to help take the tension off the front hand and provide increased accuracy.



5.10 - SLING SHOT

This is used to accelerate a rock far faster than that able to do simply by hand, what is used is two strips of material (leather) 1cm x 100cm with a pouch attached at one end and tied off using the same method as the shanghai.

At the end of one of the strips is a slit along its length of around 3cm. To use, slip your finger through the slit in the end and hold onto the other end in the same hand, load pouch with a rock and swing above your head using the inertia to keep the rock from falling out. With proper practice the free strip can be let go sending the accelerated rock towards its target.

6. FUSE/WICK & IGNITION DEVICES

6.1 - SALT PETRE FUSE

This fuse burns slowly and quite reliably, however this fuse will not burn when confined so it has to be touching the bare explosive, or can be used as a delay onto the blackpowder fuse.

To make this first you have to make a saturated solution of salt petre (potassium nitrate) and boiling water. Once you have that take a tissue and cut it into 4 even strips. Run these strips of tissue through the solution and twist each one until it resembles a

fuse and leave in the sun to dry.

What you will end up with is a 20-25cm length of fuse that will burn for approx. 6 min.

6.2 - BLACKPOWDER FUSE

A relatively fast burning fuse can be made from blackpowder turned into a pastey mess from adding a small portion of boiling water. This paste is then worked into some cotton string, (to test the string to see if it'll work burn the end of it with a match if it burns then smoulders it'll work, if it melts it won't), once the paste has been worked into the string hang the length up to dry in the sun.

Once dry the fuse can be used, avoid bending the fuse as it may become unreliable. This fuse will burn when confined however the confined portion will burn extremely fast.

Unconfined it burns at a rate of approx. 20sec-25cm. Confined it will zip from one end to the other in no time at all.

6.3 - ELECTRIC IGNITION

Electric ignition allows precise timing for the explosive to be detonated. This is easily done using homemade methods by wiring a strand of steel wool between two terminals. The bare strand is then placed within the explosive. If a current is passed through the steel wool it will become red hot and burn igniting the explosive.

Alternatively you can simply buy rocket igniters from hobby shops, these are reliable if you have a strong enough current. You have to remember the more wire you use the less power will reach the igniter.

6.4 - PARTY POPPERS

These are found in the novelty/party section of most supermarkets or newsagents, you know the things where you pull the string, it goes POP and shoots streamers out. These are very effective and reliable igniters for such things as tripwires and pull string cannons.

Another alternative is the popper things that come around at christmas time. "bonbon's" might be the name of them but I forget, anyway inside these is two thin strips of thick paper joined in the centre by some form of explosive. When pulled apart the explosive ignites and makes a cracking noise, these too can be used for ignition of an explosive device.

6.5 - INCENSE STICKS

These can be readily bought they are the things you burn in your home to make it smell nice, these can be used for extended delays where lengths of the other fuses are impractical. Each stick will smoulder for 30min or more and are used for a delay onto an easily ignited fuse such as the blackpowder fuse above. Another thing that can be used is a cigarette these are used in the same manner.

6.6 - BOUGHT FUSE

Fuse isn't that hard to buy, it's best to try the large gun shops that specialize in blackpowder weapons. A good one if you live close to Sydney is the "Colonial Gun Shop" it is available quite cheaply at \$1-2 per metre it may come off a large roll which the shop owner will cut for you or in a sealed packet under the name of "cannon fuse". Even easier to find is the proper explosive safety fuse, this can be bought at shops that sell explosives to farmers etc. for stump blasting. No licence is needed to buy the fuse as it's not classed as an explosive, it costs \$1.30 per metre, this fuse is quite thick and is a perfect fit for the neck of .22 cal cartridge cases, that would make it about .224 inches/5.66mm wide. All these fuses will burn underwater are guaranteed not to go out and burn at a steady set rate.

6.7 - SPARKLERS

Sparklers are easily bought from supermarkets or newsagents with all the other novelty items, sparklers make a reliable, consistent fuse that will burn under slight confinement. However one should always watch out for the sparks it gives off as these too will ignite the explosive.

7. INCENDIARYS

7.1 - NAPALM

Homemade napalm consists of simply thickened fuel, this is most easily done by dissolving styrofoam (white bead things in bean bags / protective packaging) in petrol until you get a white sticky mess. This method does work and you will end with a substance that will stick to anything and burn for a long period of time. This is best used with a simple explosive to spread the burning mess around the surrounding area. For this purpose a simple pipe bomb can be used, however for a greater spread, the explosive putty in the Explosive section can be loaded into a container along with blackpowder along with smokeless powder stars. Stars are added to the bomb to lengthen the flame of the explosion and more reliably ignite the napalm. Simply scoop the "napalm" into an easily burst container than load the explosive into the centre. These explosives also give a very nice looking mushroom flame upon detonation.

7.2 - THERMITE

Thermite is an intensely hot burning fuel/oxidiser mix. The oxidiser being iron oxide (rust) and the fuel being powdered aluminium.

Iron oxide may be bought from pottery shops for use in colouring the pots or can be simply made by running 12 volts from a battery charger / power adaptor into two nails (iron) in water.

This is done by attaching each wire(+ & -) to separate nails, the nails are then immersed into water in a jar making sure the nails are not touching. The power is turned on, one of the nails should begin to bubble. This is left going for as long as needed, within a few hours you will see the iron oxide forming around the nail. Within a few days the jar will fill with a blacky green coloured sludge. The solution is then filtered and dried, you will be left with an amount of very finely powdered iron oxide.

The aluminium can be made by putting Al foil in a coffee grinder, this takes at least a couple hours to form a fine enough powder.

To make thermite 3 parts aluminium are then added to 5 parts iron oxide and ground together until intimately mixed.

To ignite this mix what is needed is another very hot oxidiser mix, this can be either a coarse permanganate flash mix or a potassium nitrate - sulphur - aluminium mix.

7.3 - SHOTSHELL TRACER

A tracer can be made for a shotgun by taking an unused shotshell wad and filling it with powdered smokeless powder that has been slightly dampened with acetone. The wad is then left out in the sun to dry. Once dry the powder will have hardened into a solid block. Now take an empty, primed shotshell and load a small amount of blackpowder into it. The wad is then pushed in backwards and the shell is ready to fire. To lower the pressure the shell should be left uncrimped, the crimped section can be cut off.

NOTE - I have never fired this cartridge out of a real shotgun so unknown problems may arise, what I have done is fire it out of the R.C tank in the Improvised Weaponry section, which has a far shorter barrel than any shotgun, a longer barrel would increase the velocity which may be too much for the tracer and it may blow out, to counter this the addition of powdered blackpowder may help the flame stay alight.

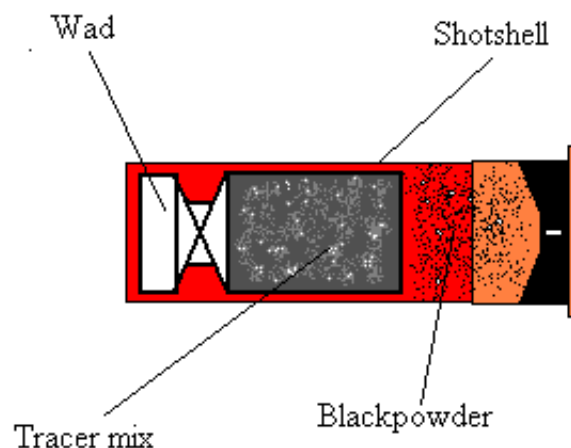

7.4 - CHLORINE FIREBOMB

This bomb uses the reaction of pool chlorine (65% calcium hypochlorite) and brake fluid. Equal parts of these two chemicals are mixed in an unsealed container. This reaction will have a delay of around 10 - 15 seconds. After the delay the composition will erupt into an intense orange flame.

7.5 - PETROL BOMB

The infamous molotov cocktail is the simplest way of spreading fire over a hard surface. A bottle is 2/3 filled with petrol, a rag is then stuffed into the neck forming an airtight fit, the rag is soaked in fuel.

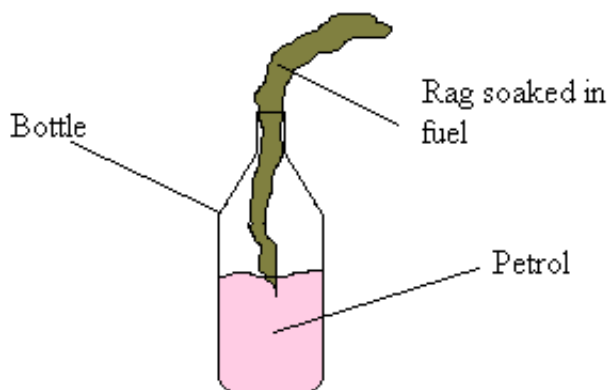

To use simply ignite the rag and throw onto a hard surface to smash the bottle, the petrol will spread all over the target and ignite from the burning rag.

7.6 - NAPHTHALENE

Naphthalene (commonly sold in flake form or as moth balls at supermarkets) is a flammable white solid, that if powdered and placed upon a charge of blackpowder or flashpowder creates a large fireball when the powder is ignited. For smaller fireballs (1 1/2m high 3/4m wide) a shotshell can be used - load an unprimed shell 1/4 way with blackpowder then ram the rest of the way with finely powdered naphthalene, cover the top with 1 or 2 layers of masking tape. push a fuse into the primer hole and its ready upsize this for more impressive results, if it explodes and doesnt ignite the naphthalene you can try mixing powdered blackpowder throughout the whole charge.

8. FUN THINGS TO MAKE AT SCHOOL

8.1 BLOW DARTS

Small, effective blow darts can be made by cutting the end off a shoe lace (make sure the hard plastic end is in good condition). the lace is then unthreaded and a pin is pushed from the back right through & out the hard plastic end. The dart is ready to be fired, this is done with a pen shell, just push it in pin first until the threads are all just inside the pen, now blow from the same end that it was inserted.



8.2 SPITBALL LAUNCHER / EXPLODING PEN

If you wish to shoot a spitball quite safely at a velocity in excess of 180 feet per second its made quite simple by using the explosive out of a party popper for propellant and a pen for the gun.

You will have to find a pen with has both ends that srcew off (papermate flexigrip is ideal). Unsrcew both ends and remove the guts of the pen, now through the hole in the point of the pen thread the string from a party popper, srcew the point back on making sure the explosive is on the inside & string outside.

Now ram a spitball, or if you are intent on hurting someone use some hard plastic projectile, what i had was the plastic cap things you srcew onto bare srcews that happened to be a perfect fit for the pen, these would penetrate an aluminium drink can.

Ram it down until its touching the explosive.

Its now ready to fire, just pull the string and BANG.

Spitball launcher

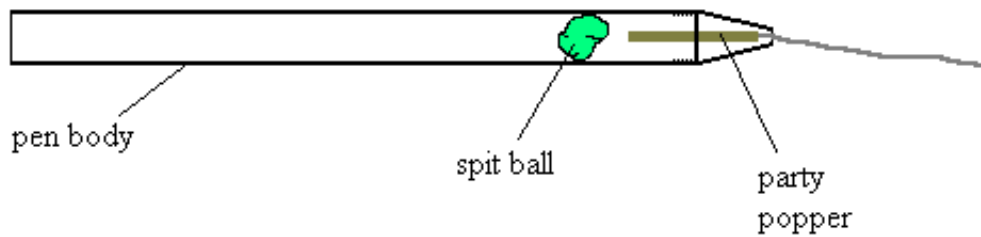

Exploding pen

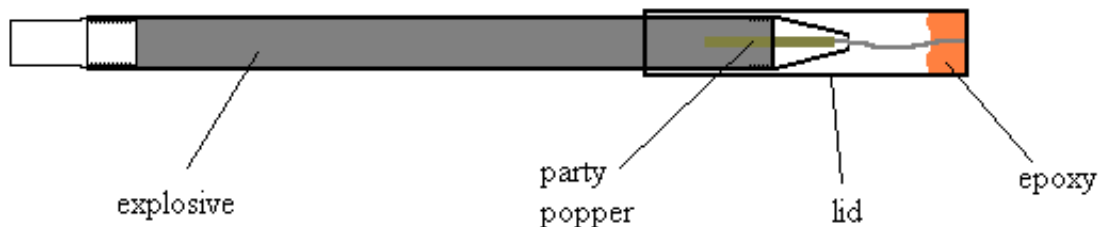

An extremely effective exploding pen can be made by using the method above, however this time fill the pen with explosive and cut & glue the string into the lid. These would be completely undetectable and would detonate when someone tried to remove the lid. If the pen was filled with blackpowder, the person would shit himself and be left with a very cut up hand, if peroxides were used theres a good chance there wouldnt be much of a hand left. Imagine the havok 10 of these would cause if placed around a school.

8.3 PEN CROSSBOW

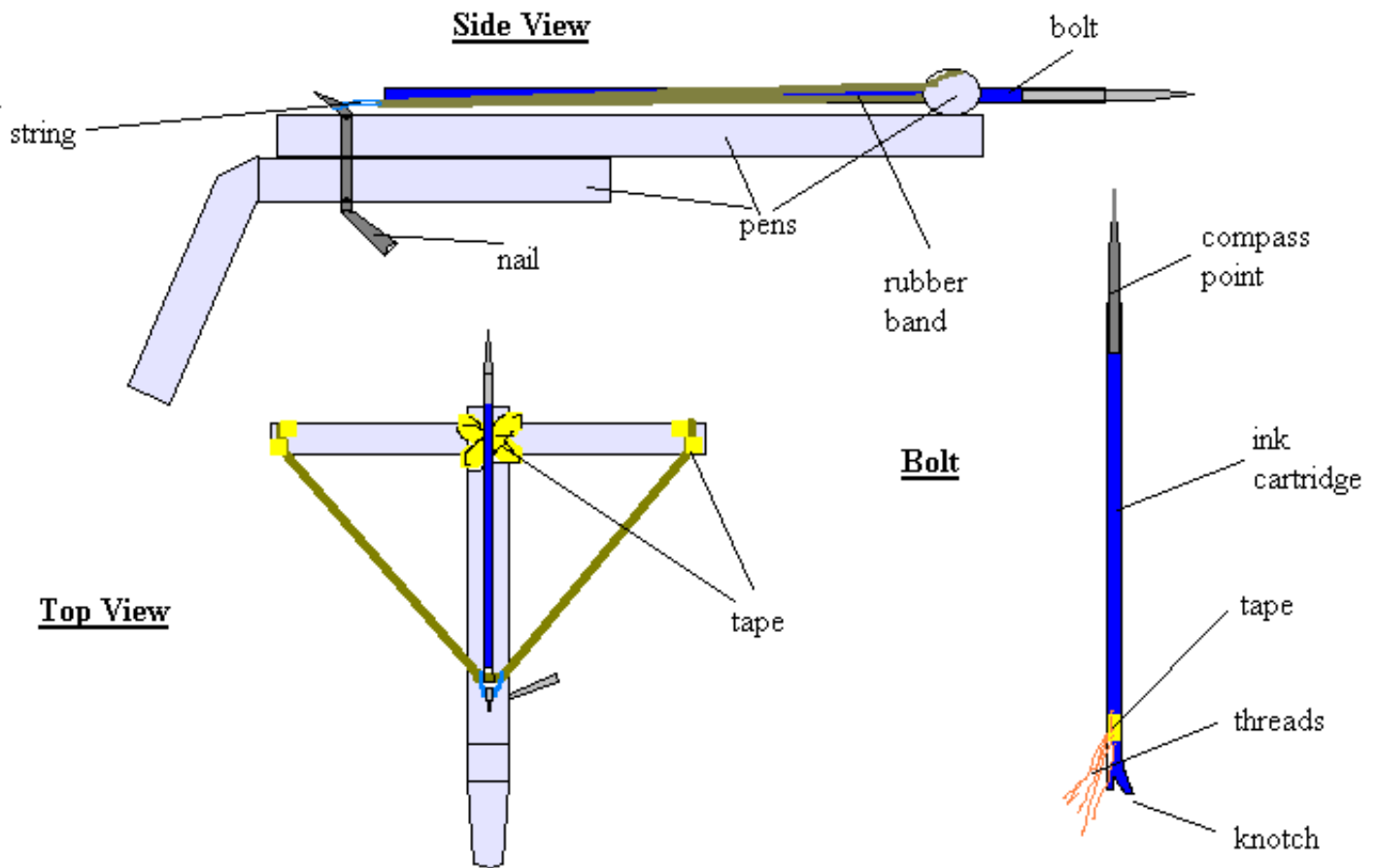

The pens are all taped together. The handle is heated over a heater until it can be bent down. To arm the weapon the rubber band is pulled back and the string loop is put around the nail, the knotch in the bolt is then pushed onto the rubber band in between the two knots from the string. To fire the nail is pulled back and the string slips off the top of the nail.

9. KILLING YOUR NEIGHBOURS CAT

9.1 - ASPIRIN

Aspirin happens to be extremely toxic to cats. All that's needed is to crush the tablets into a fine powder and mix it into some minced meat. The bait is then laid where the cat will come across it.



9.2 - SNARE

(source - "SAS survival handbook")

The above snare has been used by me numerous times on cats. This baited spring snare is activated when the cat attempts to take the bait, this pulls the bait rod off the toggle which releases the tension from a pulled down sapling, the cat's foot is caught in the

string noose & is pulled into the air.

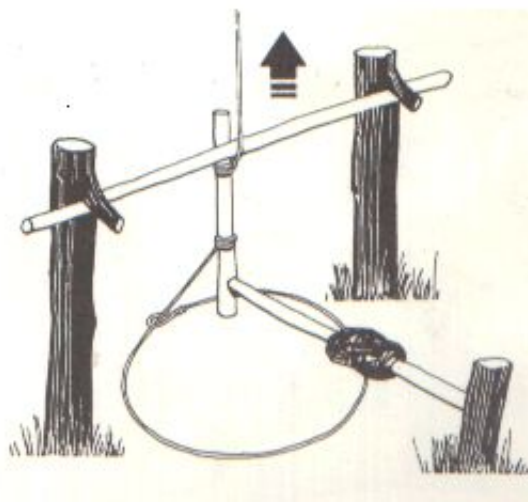

9.4 - MOUSE TRAP VARIATIONS

Using the basic action of a mouse trap it is possible to make many effective cat sized traps.



The trap above is nothing more than an oversized mouse trap. the wire is 8 gauge fencing wire that is bent into a circle (circle is vital). The back half of the circle is pinned down to a large flat board with the excess ends of wire bent in such a way as to put tension on the loop as its brought back. This is locked back by a strait piece of 8 gauge fencing wire, and the trigger is made in the shape of a standard mouse trap. Fine wire mesh is than tied around the loop to trap and hold the cat. To lock the wire loop down two nails are hammered into the board. To find where these nails should be lay the wire flat onto the board than hammer the nails just inside the the inner edge of the wire on the furthest side. now bend the nails to a 30 degree angle away from the trigger.

Now when the trap is sprung the inertia will bend the wire into an oval shape where it will go over the nails and hit the board where it regains its circular shape and locks down infront of the nail.

Another simple design that uses the same trigger as a mouse trap is shown in the photo below.

NOTE - this one above was originally made to catch birds, and is far too small for cats although the same principle would work equally well on any larger game as long as its built solid enough.



In this one, the hinged mesh box is held up via a string that is attached to the top of the box than passes over a metal rod above, than down around the locking pin of the trigger. The trap remains set because of the weight of the box holding tension onto this locking pin. When the bait plate is pushed down, the locking pin is released, the string loop around the pin slides off and the

mesh box falls over the animal.

9.5 - EXPLOSIVE TRAPS

If noise isn't a problem, a fun way to go about killing a cat is an explosive detonated when the cat triggers a switch. Very effective would be the tripwire version of the matchbox claymore with a piece of meat tied to the string.

If the claymore is placed out in the open, where as the cat is able to pull the string out to the side of the mine, the mine should be attached to a pivot. This is done by epoxying a thin piece of pipe (3/4 in. dia) vertically onto the back of the mine, to set the mine a metal stake is hammered into the ground than the pipe on the mine is slid down over the rod. When this is done if the cat pulls on the string the mine will pivot to face the cat, than BOOM.

9.6 - STEEL TRAPS

Steel traps, although now illegal to use in Australia can be picked up at second hand and antique dealers although are now expensive at around \$8-10 for a rabbit trap and anywhere from \$80 to \$200 for a dog trap.

In most cases a number of rabbit traps will do for a cat, although a dog trap which is at least 5 times bigger is a far safer bet. Its also possible to make a double sprung rabbit trap by removing a spring from one trap and attaching it to another's opposite end. The best method ive found to utilize these traps is by baiting the cat into a corner, where there is at least 3 rabbit traps in wait. Its important to wear gloves at all times when handling the bait and the traps. The traps are completely buried under the ground and the trigger plate and release latch is covered with a piece of newspaper to avoid dirt getting under the plate not letting it fall.



9.7 - CAT PRODUCTS / TAKING THE TROPHY

Why not take a momento from your kill, taking a trophy may take a little work, however i believe is well worth it. To skin the cat a sharp knife is needed, turn the cat onto its back with its legs spread (avoid tom cats as they have a habit of pissing themselves) now with the knife blade facing up cut down the inner side of a back leg, across the body and up the inner side of the other back leg. The next cut is straight up the centre of the body starting from the first cut and ending at its bottom lip. Now cut up the inner side of the front legs. The skin is now ready to be removed. Peel the skin from both legs and off the lower back, to skin the tail simply grab hold of the skin at the back of the tail at pull, it should pull right off. Now work the knife along the skin up the back and chest of the cat and peel the skin from the legs. Working carefully with the knife the skin on the head is now removed, when the ears are reached the ear is cut off leaving the ears on the skin, now remove the complete skin as well as the nose. The skin is then pegged out on a wood board with nails flesh side out, and any flesh attached to the skin is cut off, its now left to dry in a shaded area.



A cat skull is also a worthy trophy and if properly mounted looks very good. To take the skull the cat should be first skinned,

now cut the head off just in front of the front legs, tie the bottom and top jaw together and peg down onto a meat ant nest and leave until stripped of all flesh. The skull can now be boiled in chlorine to remove the remaining matter that has dried onto the skull as well as bleaching the skull white. Now the backbone is glued back together and is mounted anyway you like.



10. EASY TRICKS AND TECHNIQUES

This section was created to deal with things that are either too simple and basic or cannot be fitted into another category.

10.1 - THINGS THAT EXPLODE IN FIRES

The amount of things that fit under this heading are vast and varied but are essential to liven up a slow camping trip, nearly any sealed container will suffice but heres a few of the most common and fun.

aerosole cans - a favourite, especially if it has a flammable content. explodes with a great loud boom and fireball, fly spray seems to be one of the best.

tinned food - any sealed tin that contains air will explode when heated, they have varying results with some simply cracking and spraying boiling vapours everywhere and others that go up with a boom that leave the aerosole cans to shame, listen for the "ting" sound it'll make when shes getting ready to blow .

batterys - small watch batterys explode with a report similar to rifle primers, while with the larger ones dont seem to be as impressive often exploding with a pop but than some go bang, another unpredictable and takes longer than the others.

beer bottles - if someones stupid enough to srcREW the top back on a bottle than chuck it into the fire, you can expect an explosion that'll send glass shrapnel everywhere.

cartridges - cant suggest you go chucking rifle cartridges into a fire but obviously they explode sending brass shrapnel and a bullet in any direction, although i do doubt any of this shrapnel pieces would be lethal beyond 20 metres its still not worth the risk.

dynamite - only joking, actually burning dynamite is the accepted method of destroying the explosive.

10.2 - MAKING A BANG WITH A MATCH HEAD

To do this simple trick all you do is hammer a thisk nail into a hardwood board about 1cm and pull out, now push a match into the hole head first and twist until the red stuff comes off in the hole, push the nail back into the hole and give a sharp blow with a hammer. The friction will ignite the match head powder resulting in a small explosion and a bang.

10.3 - SPARKLER IN A BOTTLE

This is a very simple but lethal bomb, all thats needed is a glass coke bottle and a sparkler. simply cut the wire hande from the sparkler or bend it back over itself, take the bottle light the sparkler and drop it into the bottle now srcREW the lid back on. This may seem risky but it does take over half the sparkler to sufficiently pressurise a 350ml bottle to breaking point, at which when reached explodes violently sending shards of glass everywhere. Good if your going to the supermarket and want to blow something up on the way home, they dont come simpler than this..

11. BEFORE, DURING & AFTER EXPLOSION PICTURES

Below shows various pictures i have taken of explosions and the damage they cause, all photos taken during the actual

explosion were taken from a paused video screen which is the reason some arnt terribly clear. But it just goes to show that im not full of shit, all photos are original to this file.

ANNM plastique 1 - 300 grams pressed into a dead log



ANNM plastique 2 - 300 grams detonating on an Australian meat ant nest :)



Acetone Peroxide - cartridge case (.25/06) full of AP detonating under a pile of 4 bricks



HMTD - .22 magnum shell containing HMTD detonating in a toy car



ANFO - a partial detonation of an ANFO mix



Fountain - a simple pyrotechnic fountain

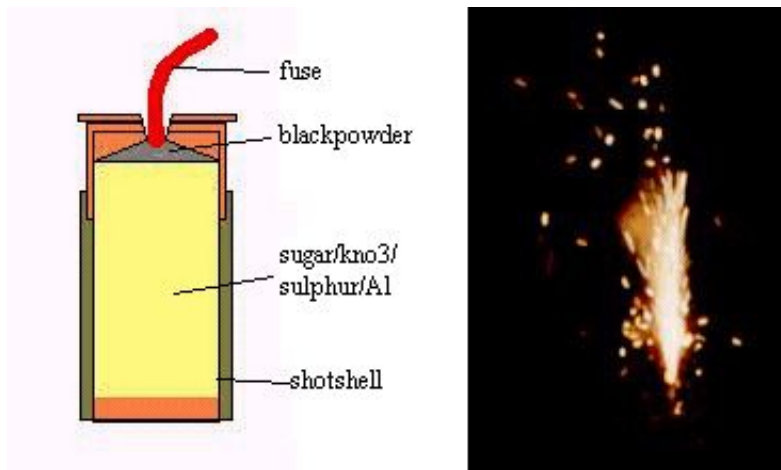

Smokeless Powder - a test of the ability to detonate double base smokeless powder. The charge on the left contains a single base powder (AR2213), the one on the right a double base (hercules green-dot). The charges were detonated simultaneously with 10 gram det. cord



Below is a comparison between 3 easy to obtain explosives, loaded into a 25/06 rifle case and initiated with safety fuse. The tests were carried out with the charge contained within a steel bucket full of sand to allow retrieval of the case. The top row contained blackpowder, second - lead styphnate rifle primers and the third - acetone peroxide (which destroyed the bucket first so not allowing further tests)



CONCLUSION

Although i have done successfully near everything present (all photos are completely original to this file), i cannot guarantee the same for you for there are far too many variables and inconsistencies within products to ever be sure as to what you have. In short, nothing is completely safe and simple mistakes can lead to disastrous ends. I have neglected safety and taken shortcuts and all too often it turns back on me with unwanted occurrences, This experience has shown me that you can never trust anything and it's this mistrust that keeps your eye on the ball and forget no safety precautions...

If you do choose to try any of the forementioned devices and explosives you must think through every step you take, for i haven't done it for you, simple things such as not completely washing the HMTD or not completely sealing the rocket in the rocket launcher can lead to serious injury and death.. The things presented here can be done safely but it has to be done with much thought and common sense.

Dont trust anything ive written as you dont know me .. you dont have a clue as to who i am or what is my intent. Both legally and health wise you could not pick a more dangerous hobby than homemade explosives and weaponry.

Above all - Think for yourself, as its your health your playing with.

~~~Lowry

Für die Katzen, stopf ich Dir irgendwann noch 300g von deinem ANNM in den Arsch.
Perverser Scheißtyp.